

Installation Guide

SPDS2107 + SPDS2117

VESA Adapters

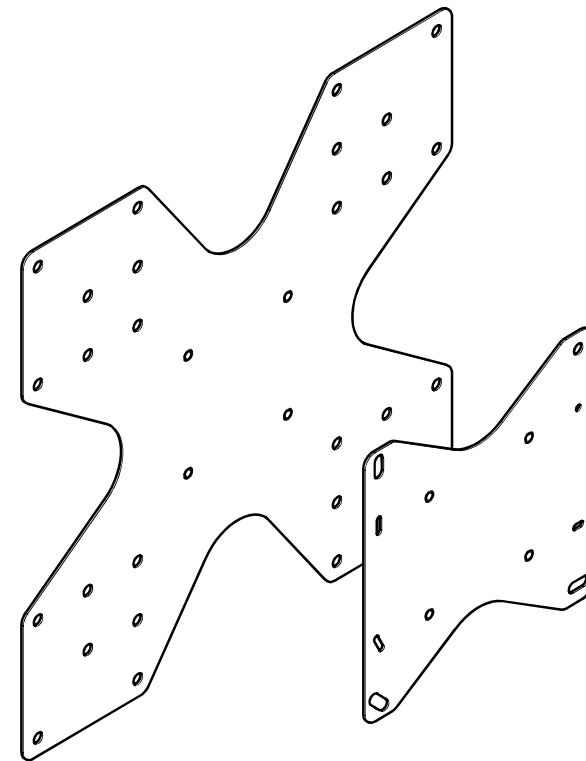



CAUTION

This product must be installed by a professional installer. It is recommended that more than one person is involved in the installation of this product.

Do not exceed the stated weight limits.
The maximum weight limit for this product is 150 kg per ceiling pole.

This product is intended for indoor use only.

If these installation instructions are not followed precisely, it could lead to product failure and potential personal injury.

Ergonomic Solutions cannot be held responsible for any failure or injury, if the installation instructions are not followed correctly.

1 Mount VESA adapter to screen

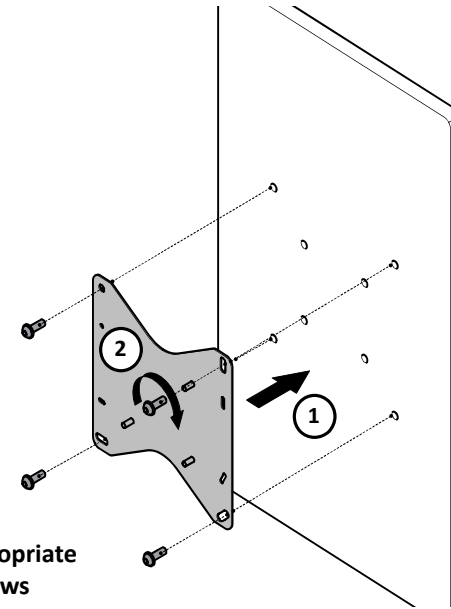

Choose the appropriate length VESA screws

Box content

SPDS2107
VESA 200

or

SPDS2117
VESA 200/300/400

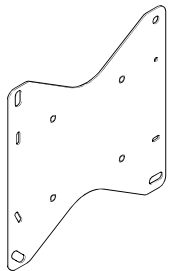



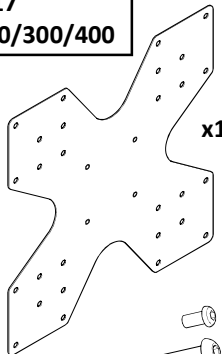



x1



x1

Fixings included in either config

-  x4 M8 x 12mm screws
-  x4 M8 x 25mm screws
-  x4 M8 x 35mm screws
-  x4 M8 x 16mm screws
-  x4 M8 x 5mm spacers
-  x4 M8 washers
-  x4 M6 nuts

2 Mount VESA adapter and screen on to the ceiling pole

